

## **Tools Required**

Modellers Knife (with a fresh blade)  
Cutting Mat  
Modelling Glue (we recommend Deluxe Materials Roket Card Glue)  
Fine Tip Applicator  
Low-tac Masking Tape  
Clips / Clamps

## **Tips**

Prior to starting your build, we recommend reading through the instructions to familiarise yourself with the build style of the kit.

We recommend painting any white edges as you remove the components from the sheet to improve the finished look. We advise watercolour paints for the best finish.

Each component is held in the sheet using score lines, indicated by a scissor symbol. To remove the component from the sheet, carefully run the tip of your modelling knife through the score line.

Remove each component as it is required to prevent losing or mixing it up with another component.

Ensure that glue is distributed evenly and not too close to the edge as it may ooze out when pressure is applied.

Use low-tac masking tape, clamps and weights to aid the assembly process.

1. Detach Wall A and place it face down on your work surface. Then fold the tabs over on themselves and glue. Repeat this step for Wall B.

 Apply firm pressure on the tabs until the glue is semi cured to stop them from lifting.

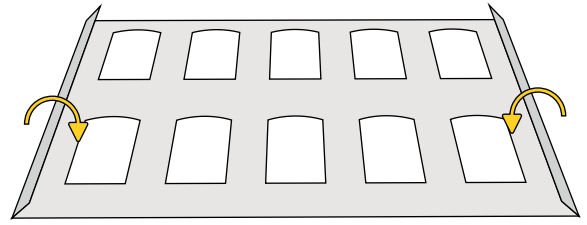
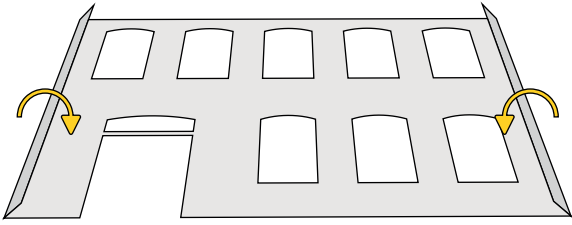

2a. Detach Wall E and glue it to Wall A.

 The window openings on Wall E are slightly smaller than the window openings on Wall A.

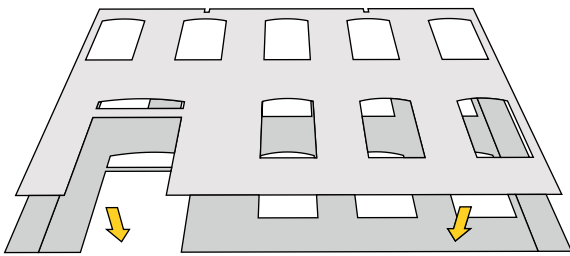

2b. Detach Wall F and glue it to Wall B.

 The window openings on Wall F are slightly smaller than the window openings on Wall B.

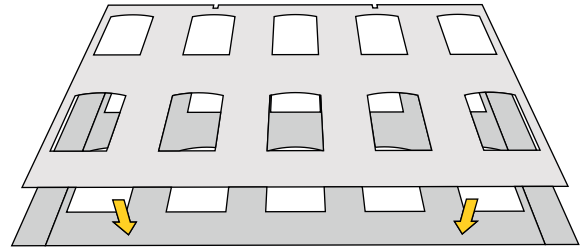

3a. Locate the Glazing Sheet, cut out the windows and then glue them into position, as per the illustration below.

 Ensure that you cut out the glazing along the outer black lines. This will allow an overhang on each piece of glazing making them easier to glue into position.

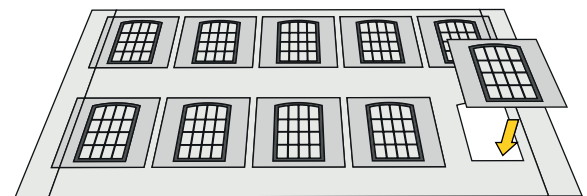
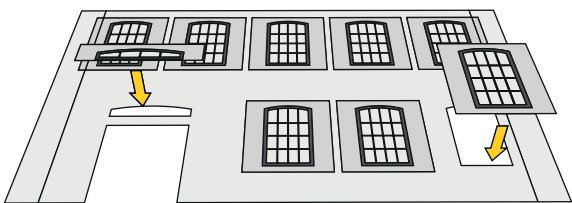

3b. Detach one of the doors (we've given two colour options) and glue it to the inside of Wall A.

 We have scored the doors giving you the option to have them open by carefully running the blade across the score lines.

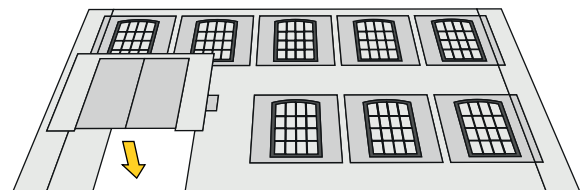

4. Fold the tabs on Wall C inwards by 90 degrees. Repeat this step for Wall D.

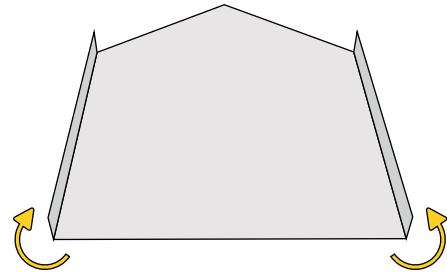
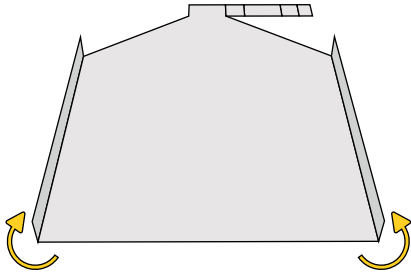

5a. Detach Wall G and glue it to Wall C.

**i** Ensure there is an even gap between the crease lines on component C and the edge of Wall G.

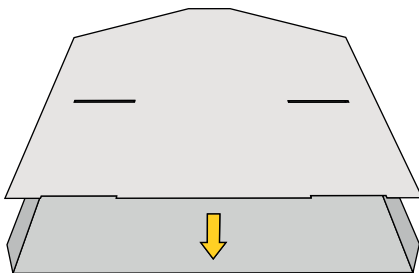

5b. Detach Wall H and glue it to Wall D.

**i** Ensure there is an even gap between the crease lines on component D and the edge of Wall H.

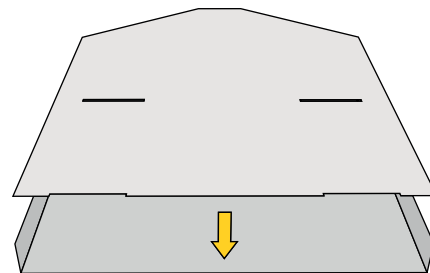

6a. Glue the tab on Wall C to Wall A, as per the illustration below.

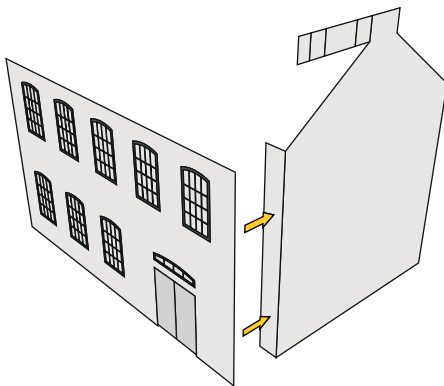

6b. Glue the tab on Wall D to Wall A, as per the illustration below.

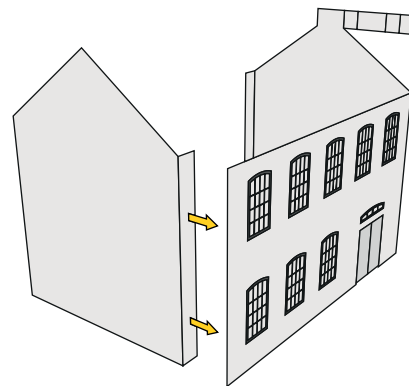

6c. Glue Wall B to the tabs on Wall C and D.

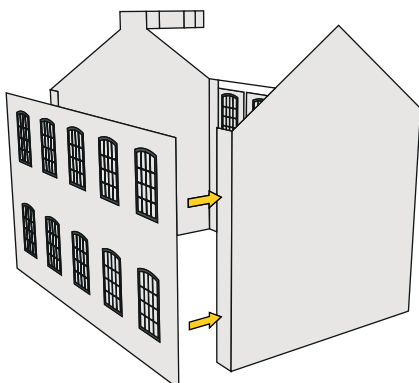

7. Detach Wall I and glue to the inside of the building. Repeat this step for Wall J.

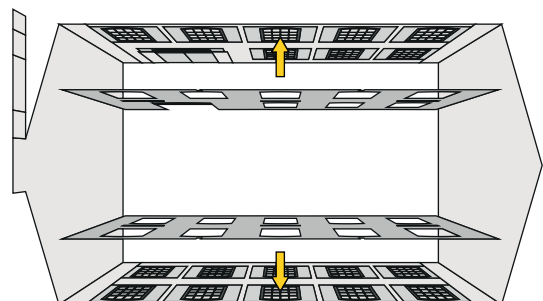

**8.** Now turn the building on its side. Detach the Ground Floor and glue it into the building.

**i** You will notice that there are notches cut out in the wall that will align with the tabs on the floor like a jigsaw. There is no tab where the floor sits behind the door.

You may find it easier to apply glue inside the notches before positioning the tabs.

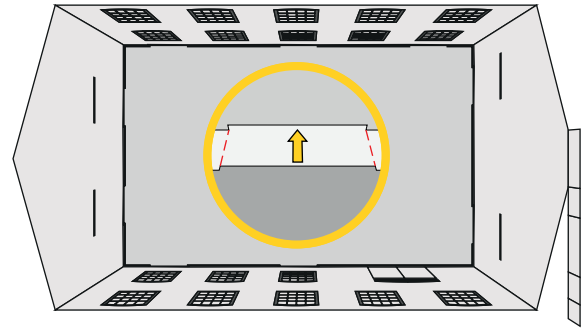

**9a.** Detach the Ground Floor Chimney Breast and then fold it along the crease lines.

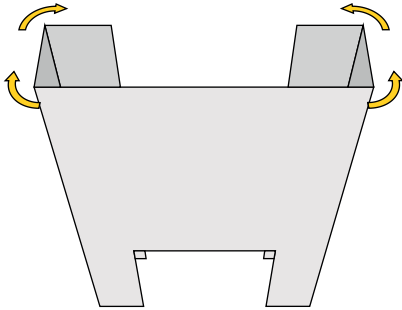

**9b.** Glue the Chimney Breast into position, as per the illustration below.

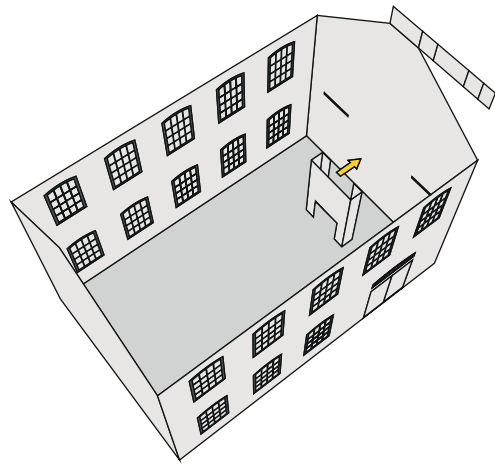

**10.** Detach the 1st Floor and glue it into position.

**i** You will notice that there are notches cut out in the wall that will align with the tabs on the floor like a jigsaw. Before glueing the component into position, ensure that the notches line up with their corresponding tabs.

You may find it easier to apply glue inside the notches before positioning the tabs.

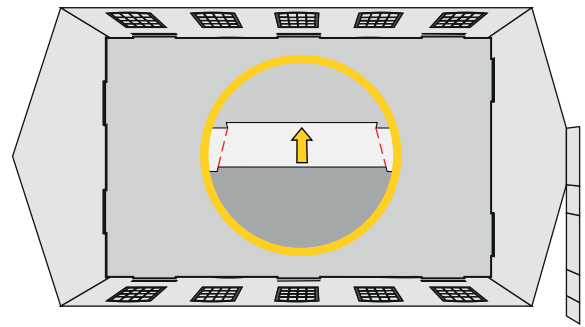

**11a.** Detach the chimney infills and fold, as per the illustration below.

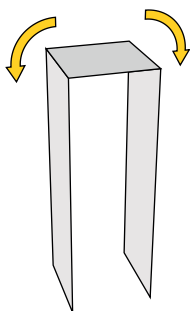

**11b.** Detach the 1st Floor Chimney and fold the upper tabs, as per the illustration below.

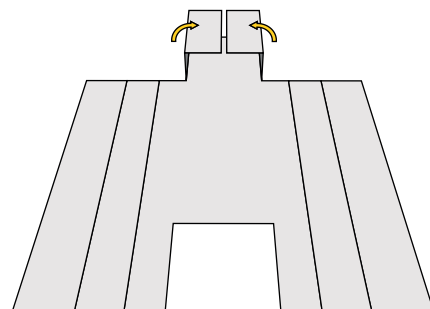

**11c.** Glue the infills into position, as per the illustration below.

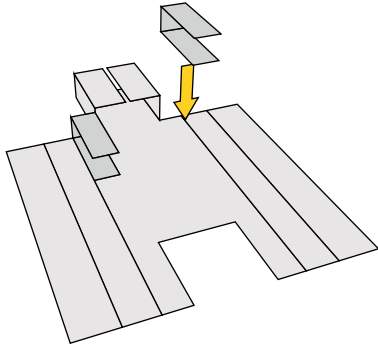

**11d.** Fold the lower tabs, wrapping them around the infills and glueing together.

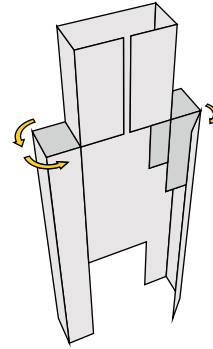

**12.** Glue the Chimney Breast into position, as per the illustration below.

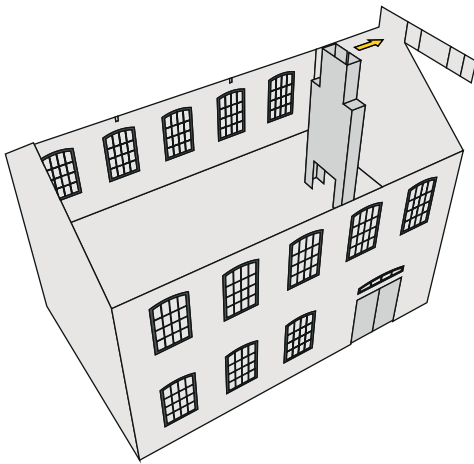

**13.** Detach the trussing (x2). Carefully glue them together, back to back. Repeat this step for the remaining trussing.

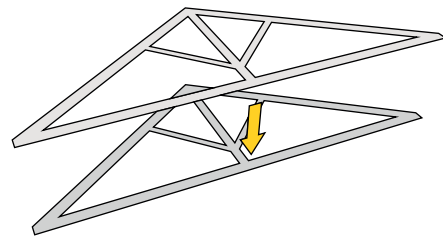

**14.** Glue the Trussing into position, as per the illustration below.

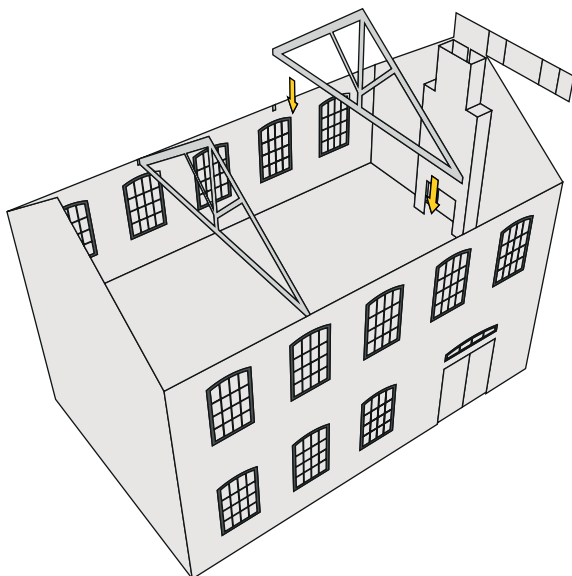

**15.** Fold the chimney stack along the crease lines and glue into position.

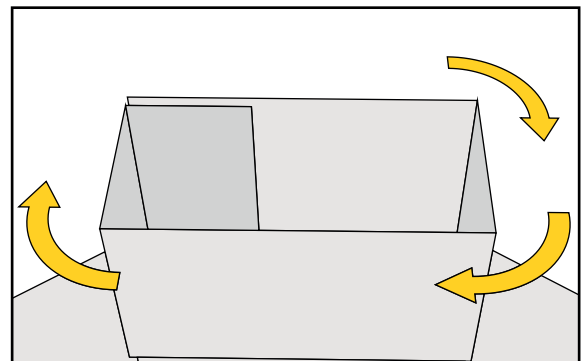

16. Apply a bead of glue across the tops of the walls. Then detach the roof and position it on top of the building.

 We recommend using ATD low-tac masking tape to assist on this step whilst the glue cures.

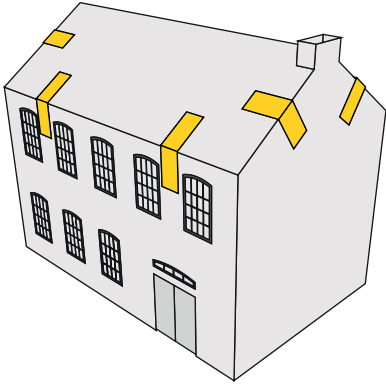

17. Detach the capping stones and place them face down on your work surface. Glue the smaller component, ensuring that it is centre aligned.

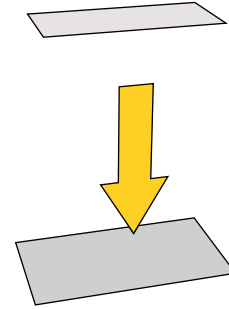

18. Apply a bead of glue across the top of the chimney stack and then position the capping stone face up, as per the illustration below.

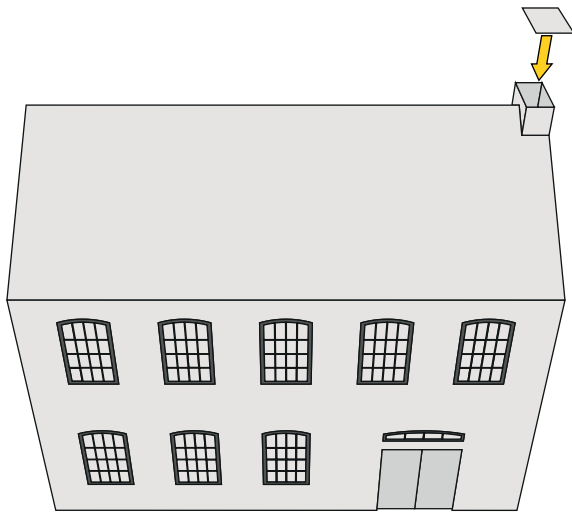

You have now completed the Stone Workshop. We hope you enjoyed and successfully built the kit! To view our other card kits, more products and find your local stockist, visit [www.atdmodels.co.uk](http://www.atdmodels.co.uk)

We'd love to see photos of your finished models. Please send them to [enquiries@atdmodels.co.uk](mailto:enquiries@atdmodels.co.uk) for a chance to be featured on our social media pages.