

PARTS DRAWING CLASS 33 VERSION 2 - Upgraded OO SCALE

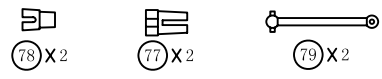

- 12 X 82 Gear wheel
- 2 X 83 Gear wheel
- 2 X 84 Worm Gear w. Bearings
- 4 X 85 Wheels 14.8 mm w. 12z
- 2 X 86 Coupler

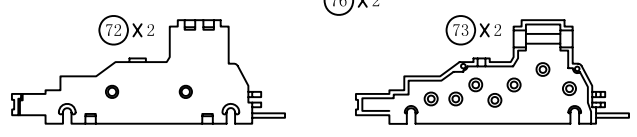
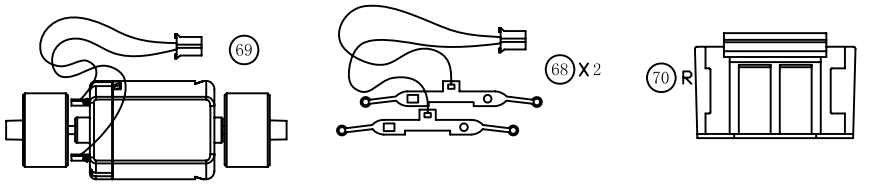
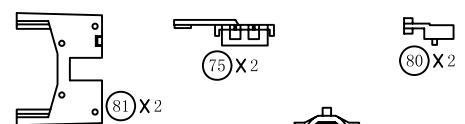
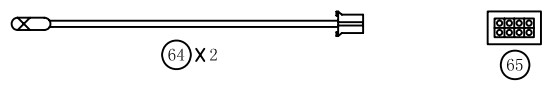
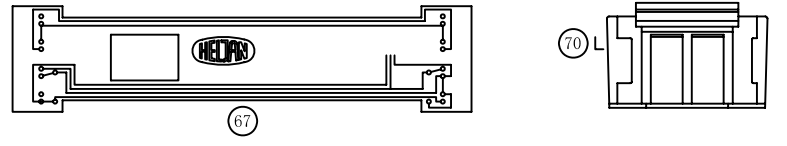
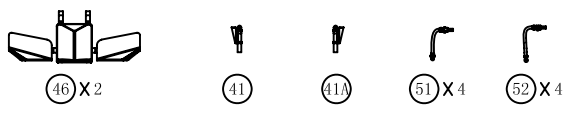
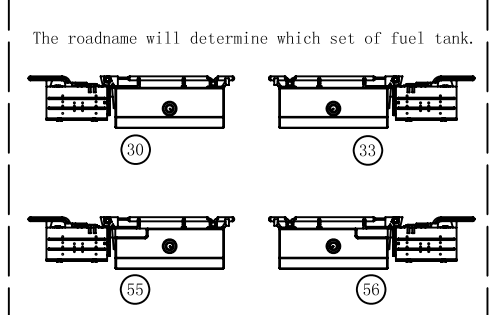
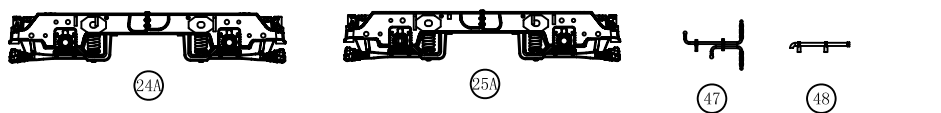
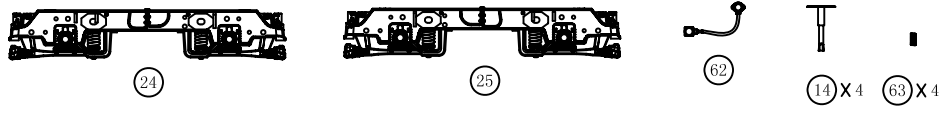
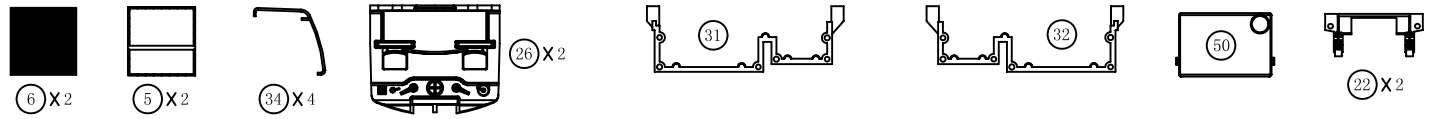
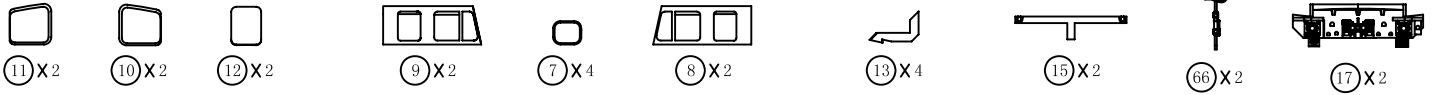
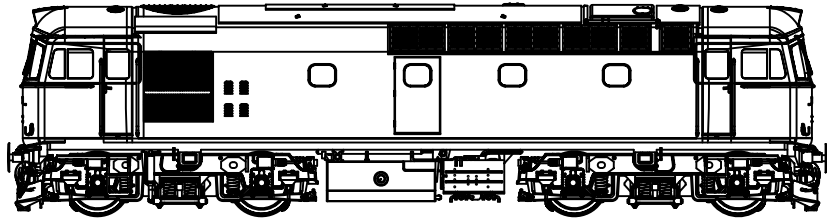
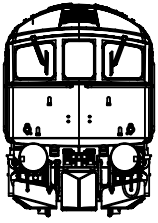